

# Welcome

This Quick Start Guide provides all the information you need to get your product up and running. Please fully unfold this guide and follow the numbered steps below. If you need more detailed instructions, a full user guide is available to download in PDF format from [www.bt.com/help/userguides](http://www.bt.com/help/userguides)

We haven't printed a full user guide as we're working to make our products greener, so please consider the environment before printing.

If you cannot find the answer to your problem in the full online user guide, then please call the Helpline on 0800 218 2182\* or email [bt.helpdesk@vtecheurope.com](mailto:bt.helpdesk@vtecheurope.com).

BT is a sustainability leader

To find out how we're making our products greener visit

[bt.com/betterworld/products](http://bt.com/betterworld/products)





\* Calls made from within the UK mainland network are free. Mobile and International call costs may vary.

## 1 Getting started

Place your BT Freestyle 710 within 2 metres of the mains power socket and telephone socket so that the cables will reach.

The handset range is up to 300 metres outdoors and 50 metres indoors (in ideal conditions). Try to position the phone at least 1 metre away from other electrical appliances to avoid interference and help maximise the handset range.

### Setting up

1. Plug the mains power adaptor (item code 043650) into the socket marked  on the underside of the base and plug the telephone line cord into the socket marked . **Only use the cables provided with the product.**
2. Plug the other end of the power adaptor into the wall socket and switch the power on. The Power indicator on the base lights up.
3. Rechargeable batteries are pre-installed in the handset. Pull the plastic tab as instructed to activate them.
4. Place the handset on the base to charge for at least 20 hours. An animated battery icon  will be displayed on the handset screen and to indicate the handset is charging and the Charging indicator on the base will light up.
5. When the handset is fully charged the  icon will be displayed. Now plug the telephone line cord into the telephone wall socket.

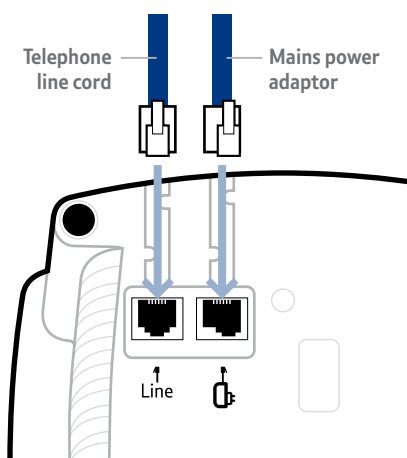

### Set up your additional handsets (multipack owners only)

For each additional handset and charger:





1. Insert the power adaptor cable (item code 043650) through the channel at the rear of the charger and insert the plug into the power socket. Plug the other end into the wall socket and switch it on.
2. Prepare the battery as detailed in point 3 above. Then place the handset on the charger to charge for at least 20 hours.

Additional handsets supplied as part of a multipack are pre-registered to the base so, once charged, are ready for use. Each handset will display its own handset number: 1, 2, 3 and so on.

Your BT Freestyle 710 is now ready for use.

## 2 Navigating the menus



Your BT Freestyle 710 has an easy to use menu system. Each menu has a list of options, which you can see on the menu map below.

1. From standby, press  to open the main menu.
2. Then use the  and  buttons on the side of the handset to scroll through the available options and press  to select an option or  to return to the previous screen.

To exit a menu and return to standby, press .

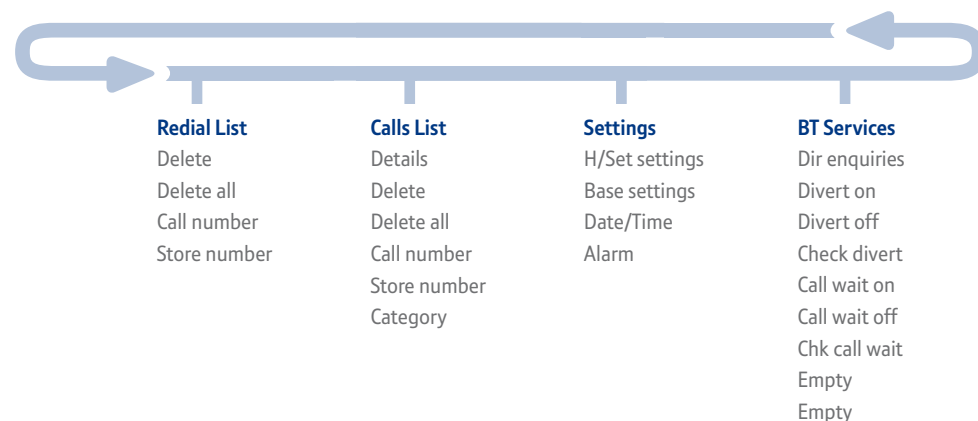

### Menu map







Some menus are accessed by pressing the relevant feature button, for example  for the phonebook,  for the redial list and  for the calls list.

## 3 Making and receiving calls



### Make/end a call

Press . When you hear the dial tone, dial the number. To end the call, press , or replace the handset on the base or charger.

### Redial from the 5 number redial list

Press , the last number you dialled is displayed. Scroll  or  to the number you want to redial and press .

### Secrecy (Mute)



During a call, press . **Mute on** is displayed and you can talk without your caller hearing you. Press  again to resume your call.

### Receiving calls



When you receive a call, the base and handset will ring. To answer the call press . Or if the handset is on the base or charger, simply lift it to answer the call.

### Handsfree

Handsfree lets you talk to your caller without holding the handset. It also enables other people in the room to listen to your conversation over the loudspeaker.

Before dialling, or during a call, press . You will hear your call through the handset loudspeaker. Press  to switch the call between the earpiece and the loudspeaker.

### Earpiece/handsfree volume

During a call, press  or  to adjust the volume of the earpiece or loudspeaker.

















## 4 Special features

Your BT Freestyle 710 has some special features, these include: a 50 entry phonebook, a speed dial facility and Caller Display with a 20 entry calls list.



### 50 Entry phonebook

Not only can you store up to 50 names and numbers in the directory but you can store them under different call groups with their own ringtones, eg. family, business, friends.

### Add a new phonebook entry

1. Press . The phonebook menu is displayed.
2. When storing the first entry: **New entry** is highlighted. Press .  
When storing subsequent entries, the phonebook list is displayed with the first entry highlighted. Press . **New entry** is highlighted. Press .
3. Using the letters on the keypad, enter the name and press . For example, press  once for **A**, or twice for **B**. If you make a mistake, press  or  to move the cursor left and right and  to delete. Press  to enter a space,  for punctuation and  to switch between upper and lower case.
4. Enter the phone number and press .
5. If you don't want to store the number in a group, press . If you want to add the entry to a group, scroll  to the group you want then press .
6. Press  to exit and return to standby.

### Dial from the phonebook

From standby, press . The first entry is displayed. Scroll to the entry you want or search alphabetically and press  to dial.

## Speed dial

You can assign a phonebook entry to each of the **2** to **9** keypad buttons for speed dialling. Button **1** has the BT Freestyle Helpline number already pre-stored.

### To assign a phonebook entry to a speed dial button

1. Press **Phonebook**.
2. Scroll **▼** to **Speed Dial** and press **✓Menu**.
3. Scroll **▲** or **▼** to the speed dial button number to which you want to assign the phonebook entry and press **✓Menu**.
4. Scroll **▲** or **▼** to the entry you want to store and press **✓Menu** to confirm.
5. Press **☎** to exit and return to standby.

### To speed dial a number

1. Once you've assigned phonebook entries to speed dial buttons as above, press **and hold** the speed dial button (**2** to **9**) with the number you wish to speed dial.
2. The display shows **Calling** and the number being dialled.

### To edit or delete a speed dial number

1. Press **Phonebook**, scroll **▼** to **Speed Dial** and press **✓Menu**.
2. Scroll **▲** or **▼** to the speed dial button number you want to edit or delete and press **✓Menu**.
3. The name and number is displayed. Press **✓Menu**. **Edit** is displayed.

**To edit the speed dial number:** Press **✓Menu**, then scroll **▲** or **▼** to the new phonebook entry you want to assign and press **✓Menu** to save.

**To delete the speed dial number:** Scroll **▼** to **Delete** and press **✓Menu**. Press **✓Menu** again to confirm, **Deleted** is displayed. The actual phonebook entry will not be deleted.

4. Press **☎** to exit and return to standby.

## Caller Display and the calls list

You must subscribe to a Caller Display service for this feature to work. Your network provider may charge you for this service.

Caller Display allows you to see the number of the person calling you before you answer the phone. The calls list holds details of your last 20 callers, including the phone number, date and time of the call. If a number matches a stored directory entry, the caller's name is displayed instead. When you have new missed calls in the list, **New call** will be displayed.

### View entries and dial from the calls list

1. Press **▼** to open the calls list. If you have received any calls, the most recent call is displayed.
2. Press **▲** or **▼** to scroll through the list. To view details of the call press **✓Menu**. **Details** is highlighted, press **✓Menu** again. Press **⌫Back** to return to the previous menu.
3. Press **☎** to dial the entry displayed. Or, press **✓Menu** to access further calls list options, eg. copy the number to the phonebook or delete entries.

## Personalise your phone

Through the Handset settings and Base settings menus, you can change the handset and base ringer volume and ringtone, switch key beeps on/off, change the handset name (particularly useful if you have more than handset), change the display contrast and even use your handset as an alarm clock. See 'Menu map' in Section 2 for all the available settings.

1. Press **✓Menu** to open the menu, then scroll **▼** to **Settings** and press **✓Menu**.
2. Scroll **▼** to **H/Set settings** or **Base settings** and press **✓Menu**. Then press **▲** or **▼** to scroll through the options available.

For a full explanation of features and instructions, please see the main user guide online at [www.bt.com/help/userguides](http://www.bt.com/help/userguides)

# Troubleshooting

Most problems are caused by something very simple and can be fixed with a few simple checks:

- Make sure both the mains power adaptor cable and telephone line cord are plugged into the correct sockets and plugged in at the wall.
- Make sure you use all the cables and batteries that came in the box, not those from a previous product.
- If you experience poor speech quality or interference, make sure the product is not located too close to other electrical appliances. This can also help improve the handset range from the base.
- Make sure you charge the batteries for at least 20 hours before first use to ensure maximum battery performance. The charge capacity of the batteries will decrease over time.

### Using your BT Freestyle 710 on a broadband Internet enabled line?

Remember to plug the phone into the wall socket via an ADSL microfilter if you have broadband Internet on your phone line, otherwise you may have problems with this product and your broadband service. Additional BT ADSL microfilters can be purchased from [www.shop.bt.com](http://www.shop.bt.com)

# General information

For information on safety instructions, cleaning, technical information or connecting to a switchboard, please refer to the 'General Information' section in the full user guide at [www.bt.com/help/userguides](http://www.bt.com/help/userguides)

## Guarantee

Your BT Freestyle 710 is guaranteed for a period of 12 months from the date of purchase.

Subject to the terms listed below, the guarantee will provide for the repair of, or at BT's or its agent's discretion the option to replace the BT Freestyle 710, or any component thereof, (other than batteries), which is identified as faulty or below standard, or as a result of inferior workmanship or materials. Products over 28 days old from the date of purchase may be replaced with a refurbished or repaired product.

The conditions of this guarantee are:

- The guarantee shall only apply to defects that occur within the 12 month guarantee period.
- Proof of purchase is required.
- The equipment is returned to BT or its agent as instructed.

This guarantee does not cover any faults or defects caused by accidents, misuse, fair wear and tear, neglect, tampering with the equipment, or any attempt at adjustment or repair other than through approved agents.

This guarantee does not affect your statutory rights.

For further information within and outside the 12 month guarantee, please refer to the full user guide at [www.bt.com/help/userguides](http://www.bt.com/help/userguides)

## Product disposal instructions



The symbol shown here and on the product means that the product is classed as Electrical or Electronic Equipment and should not be disposed with other household or commercial waste at the end of its working life.

The Waste of Electrical and Electronic Equipment (WEEE) Directive (2002/96/EC) has been put in place to recycle products using best available recovery and recycling techniques to minimise the impact on the environment, treat any hazardous substances and avoid the increasing landfill.

### Product disposal instructions for residential users

When you have no further use for it, please remove any batteries and dispose of them and the product as per your local authority's recycling processes. For more information please contact your local authority or the retailer where the product was purchased.

### Product disposal instructions for business users

Business users should contact their suppliers and check the terms and conditions of the purchase contract and ensure that this product is not mixed with other commercial waste for disposal.

## R&TTE Directive & Declaration of Conformity

This product is intended for use within the UK for connection to the public telephone network and compatible switchboards.

This equipment complies with the essential requirements for the Radio Equipment and Telecommunications Terminal Equipment Directive (1999/5/EC). For a copy of the Declaration of Conformity please contact the BT Freestyle Helpline on 0800 218 2182\* or email [bt.helpdesk@vteceurope.com](mailto:bt.helpdesk@vteceurope.com)

\* Calls made from within the UK mainland network are free. Mobile and International call costs may vary.

# BT Freestyle 710 Quick Start Guide



Bringing it all together

## BT is a sustainability leader

To find out how we're making our products greener visit

[bt.com/betterworld/products](http://bt.com/betterworld/products)

### Offices worldwide

The services described in this publication are subject to availability and may be modified from time to time. Services and equipment are supplied subject to British Telecommunications plc's respective standard conditions of contract. Nothing in this publication forms any part of a contract.

© British Telecommunications plc 2008.  
Registered Office: 81 Newgate Street, London EC1A 7AJ.  
Registered in England No. 1800000.

Designed and produced by The Art & Design Partnership Ltd.

Printed in China / Issue 2 / ADP05-08



A full user guide can be downloaded in PDF format from [www.bt.com/help/userguides](http://www.bt.com/help/userguides)  
Please consider the environment before printing.



This guide can be recycled.

